

ATTACHMENT TOUCH PANEL KNX-304-13-IN



CONTENTS

1. COMMUNICATION OBJECT	2
1.1. OBJECTS CORRESPONDING TO CHANNELS	2
1.2. LOGICAL OBJECTS	2
2. ETS PARAMETER	2
2.1. GENERAL SETTINGS	2
2.2. CONFIGURATION	3
2.3. SAME PARAMETER CONFIGURATION	3
2.3.1. BLOCKING OBJECTS	3
2.4. SET OF MODEL PARAMETERS CONFIGURATION	3
2.4.1. DIMMER	3
2.4.2. CURTAIN CONTROL	3
2.4.3. SWITCH	4
2.5. INDEPENDENT MODEL PARAMETERS CONFIGURATION	4
2.5.1. SWITCH	4
2.5.2. SCENARIOS (SCENE)	6
2.5.3. AS LONG/SHORT PRESS THE SWITCH (THE SWITCH SHORT/LONG)	6
2.5.4. A KEY MOVE LIGHT (ONE BUTTON DIMMING)	7
2.5.5. SINGLE BOND CURTAIN CONTROL (ONE BUTTON SHUTTER)	8
2.6. LOGIC (LOGIC)	8
2.6.1. SWITCH FUNCTION (LOGIC OBJECT TYPE SWITCH)	9
2.6.2. SCENE FUNCTION (LOGIC OBJECT TYPE SCENE)	9
2.6.3. LOGIC OBJECT TYPE BYTE VALUE (LOGIC OBJECT TYPE BYTE VALUE)	9

1. COMMUNICATION OBJECT

1.1. OBJECTS CORRESPONDING TO CHANNELS

Each channel has five corresponding object numbers, which are 0-4,5-9, and so on. Object locations are permanently occupied and do not change with mode changes. This means that if channels A and B are configured as combinational patterns (Grouped), they collectively use objects numbered 0-4. Objects numbered 5-9 are no longer used, but their respective positions in memory remain occupied. Channels C and D continue to be numbered from 10, 10-14,15-19, and so on.

In addition,12 logical objects follow the channel objects, which are numbered 40-51 for channel 8, 20-31 for channel 4, and so on.

The figure below shows a channel configuration diagram with channel 1/2 configured in combination mode and dimming function. Channel 3/4 is configured for independent mode, 3 for switch function, and 4 for scene function. Channel 5/6 is configured for independent mode,5 for curtain control function, and 6 for on-off function. Channel 7/8 is configured for combination mode with curtain control function:

Number	Name	Object Function	Description	Group Addresses	Leng...
0	Buttons 1 / 2	Dimming on/off			1 bit
1	Buttons 1 / 2	Dimming			4 bit
10	Button 3	Switch			1 bit
11	Button 3	Value for toggle			1 bit
17	Button 4	Scene			1 Byte
20	Button 5	Shutter			1 bit
21	Button 5	Blinds/Stop			1 bit
25	Button 6	Switch			1 bit
30	Buttons 7 / 8	Shutter Down/Up			1 bit
31	Buttons 7 / 8	Stop/Blinds Open/CL...			1 bit

Figure 1: Channel object configuration

If a group of channels is banned, then the corresponding channel object won't be displayed, at the same time, the corresponding parameter is not configurable.

The following table shows the related objects corresponding to a channel. The same number indicates that the functions of the objects are different in different configuration modes:

No	Function	Uses	Data point type	Read and Write
0	Switch	Edging control	DPT 1.001	read
0	Send forced setting	Send forced setting	DPT 2.001	read
0	Shutters down/up	Curtain controls	DPT 1.008	read
0	Dimming on/off	Flip dimming on/off	DPT 1.001	read
0	Switch on/off	Double key control switch	DPT 1.001	read
0	Send value	Send the set value	DPT 5.001	read
0	Push button short	Send the short press action	DPT 1.001	read
1	Value for toggle	Edging controls the flip value	DPT 1.001	write
1	Stop/Blinds open/close	Curtain Drive/Blinds Stop	DPT 1.009	read
1	Dimming	Dimming	DPT 3.007	read
2	Scene	Scene	DPT 18.001	read
2	Value for change of direction	Direction of curtain movement	DPT 1.001	read
2	Push button long	Send the long-press behavior	DPT 1.001	read
+5	Next channel			

Figure 2: Single-channel objects

1.2. LOGICAL OBJECTS

Each device has 4 logical functions. Each logic function is equipped with two logic input objects and one logic output object, and can choose any channel to participate in the logic operation. Object numbers start at 30 and end at 41 for 6-channel devices, and start at 40 and end at 51 for 8-channel devices.

The following table is for 6-channel devices, logical object 1:

Number	Name	Object Function
30	Logic	Input 1 A
31	Logic	Input 1 B
32	Logic	Output 1

Figure 3: Logical object

If the logical function is not in use, the corresponding object will not be displayed. Each device contains four logical object function blocks. The following table shows the corresponding objects for a logical function:

No	Function	Uses	Data point type	Read and Write
30/40	Logic input 1A	Logic Input A	DPT 1.001	write
31/41	Logic input 1B	Logic Input B	DPT 1.001	write
32/42	Logic output 1	Logic Output 1	DPT 1.001	read
32/42	Logic output 1 scene	Logic Output 1 Scene	DPT 18.001	read
+3	Next logic block			

Chart : 3 Logical Object description

The two logical input objects (A/B) of each logical block can receive external signals for logical operations. In addition, each channel of the device can be used as a logical input and, after being selected through the configuration, can participate in the logical operation.

2. ETS PARAMETER

2.1. GENERAL SETTINGS

The following parameters affect all channels:

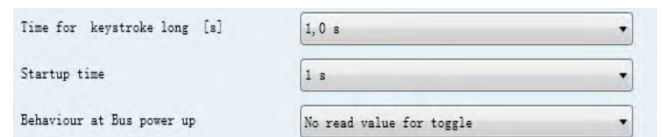

Figure 3: General Settings

The following table shows the parameter description:

Parameter names	Range [Default value]	Remarks
Time for keystroke long	0.1-30s [0.8s]	Long key decision time (greater than the value of the long key), need to distinguish the length of the key must determine the value
Startup time	0-60s [1s]	Time to wait before starting the application after the device is powered on
Behavior at bus power up	No read value for toggle Read value for toggle	Whether to read the rollover value when the device is reset, which defaults to 0

Figure 4: General Settings



2.2. CONFIGURATION

Below is the channel feature selection:

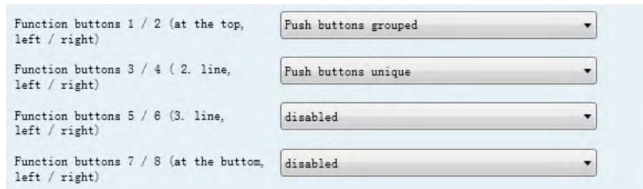

Figure 4: Channel mode

Function description:

Parameter name	Range [Default value]	Remarks
Function Button 1/2	Disabled Channels grouped Channels unique	Disabled Indicates the channel working mode Not working,grouped means two adjacent groups of channels Used together,unique means the channels work independently.

Figure 5: Channel parameters

2.3. SAME PARAMETER CONFIGURATION

2.3.1. BLOCKING OBJECTS

A channel can activate blocking in either combination mode or standalone mode. The difference is that in combination mode, two adjacent channels share a blocking object, while in independent mode, channels have their own blocking object.

The following is the description of the object:

No	Name	Length	Usage
4	Blocking object	1 bit	When a value of 1 is received, block the channel (the channel will no longer produce any action) and the value of 0 returns to normal

Figure 6: Blocking objects

2.4. SET OF MODEL PARAMETERS CONFIGURATION

The following table shows the group mode parameter options:

Parameter names	Range [Default value]	Remarks
Button A/B	Dimming Shutter Switch	Working mode selection: Dimming, Curtain, Switch
Dimming function A/B	Brighter/Darker Darker/Brighter	Set the dimming mode to A for the former and B for the latter
Shutter function A/B	Up/Down Down/Up	Set the curtain controls to A for the former and B for the latter
Switch function A/B	On/Off Off/On	Set the switching mode to A for the former and B for the latter
Blocking Object	Inactive Active	Set blocking, disabled by default

Figure 7: Combination Mode parameters

When the combination mode is selected, the two adjacent channels will be configured for the combination function.

The following figure shows the group relationship of the combined mode keys (channels): A/B group, C/D group, E/F group, and G/H group.

A	B
C	D
E	F
G	H

2.4.1. DIMMER

The two-button dimming feature works in combo mode. The following image shows the parameter options:



Figure 5: Combination mode parameters

Parameter description

NO.	Name	Length	Prospects
0	Dimming on/off	1 bit	Switch function, short press is effective.
1	Dimming	4-bit	Dimming function, long press effective, relative dimming.

Figure 8: Combination Mode Dimming object

When a group of channel configured to the dimming function, there will be two objects, a corresponding short key, one object used to control and off, a long four object corresponding to the key, is used to control the light, because it is the four values, so for a relatively dimming function.

Brighter/Darker or Darker/Brighter can be configured so that the former corresponds to the first input and the latter to the second input. For example, if channel A/B is configured with Brighter/Darker, channel A is brightened and channel B is dimmed. When you press A short button, channel A directly lights up and channel B directly turns off the light. For A long key, channel A slowly lightens the light according to the set time, and channel B slowly dims the light. For long key dimming, if you release the key operation at any time in the middle, the dimming will stop and the light will keep the current brightness. When dimming again, the dimming will continue to start from the current brightness. When the brightness is adjusted to the maximum or minimum, the brightness will not change.

Below is a two-channel dimming:

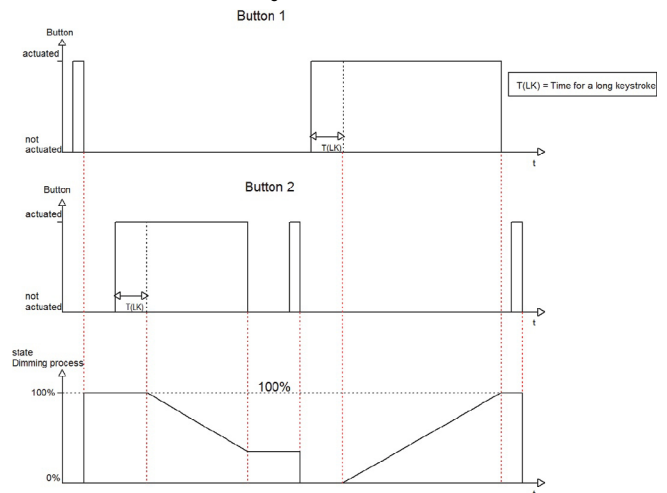

Figure 6: Double key dimming waveform

2.4.2. CURTAIN CONTROL

Two key curtain control. Curtains, blinds can be controlled. The following picture shows the parameter description:



Figure 7: Double key curtain parameters



NO.	Name	Length	Purpose
0	Shutter Down/Up	1 bit	Drive curtains up and down, long keys work.
1	Stop/Blinds Open/Close	1 bit	Stop moving, short key works.

Figure 9: Double key curtain object

When channel A/B is configured as curtain control and the parameter is selected Up/Down, then the device will send A 0 signal when holding down the A key and the curtain will move up, and a 1 signal when holding down the B key and the curtain will move down. Pressing A or B short will send a stop signal. If the parameter is Down/Up, A/B switches. If the operation mode is selected as short=move/long=stop/slats, then the short key is dimmed and the long key is stopped.

2.4.3. SWITCH

Switch control can be realized when two channels are configured in switch mode.

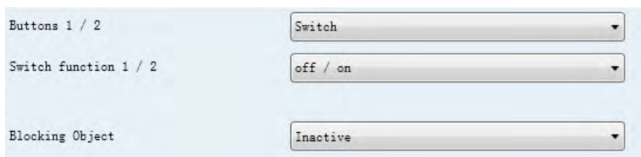

Figure 8: Double key switch parameters

Description of switch object:

NO.	Name	Length	Purpose
0	Switch On/Off	1 bit	Switch object

Figure 10: Double key switch object

When channel A/B is configured in combination switch mode and the parameter On/Off is selected, pressing A will send a 1 signal and pressing B will send a 0 signal. On the contrary, a 0/1 signal is sent.

2.5. INDEPENDENT MODEL PARAMETERS CONFIGURATION

There are 7 functions available for the channel to work in standalone mode:

- ▼ Inactive
- ▼ Switch
- ▼ Scene
- ▼ Switch short/long
- ▼ One button dimming
- ▼ One button shutter

Inactive indicates that the channel is forbidden, and the parameters corresponding to the channel are no longer displayed.

2.5.1. SWITCH

The switch function in independent mode can respond to different key actions (press, release), as well as the delay send function. When one of the suboptions is selected, more additional parameter options will appear. See the following section for parameter descriptions.

The following figure shows the switch function options:

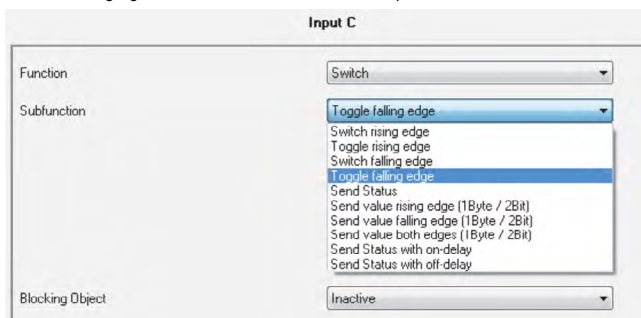

Figure 9: Switch parameters

2.5.1.1. UP/DOWN DELAY SWITCH (THE SWITCH FALLING EDGE/RISING EDGE/BOTH EDGE)

Edge extension configuration parameter table:

Parameter names	Range [Default value]	Remarks
Value for rising/falling edge	On Off	On/off can correspond to press/release at will

Figure 11: Edge extension parameter configuration

When the channel is selected to Switch rising edge or Switch falling edge, an On or Off signal will be sent under the corresponding action.

The following figure shows the effect of sending On signals when the channel is configured as Switch rising edge:

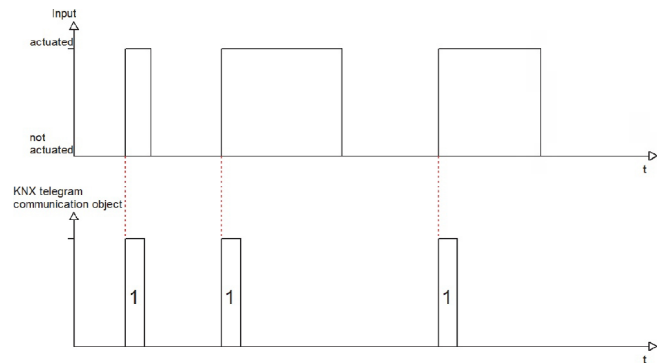

Figure 10: Press to send the On signal

The following table shows the corresponding communication objects:

NO.	Name	Length	Purpose
0	Switch	1	Pressing the key will send the

Figure 12: Switch edge extension control

2.5.1.2. UP/DOWN DELAY (TOGGLE RISING/FALLING EDGE)

Channels can be configured to either rise (hold down) flip, or fall (release) flip output. Each flip is based on the last State feedback, which means that the Value for toggle must be associated with the target state object (State) for it to work properly.

Here is the channel configured with the drop delay (release), and the flip function:

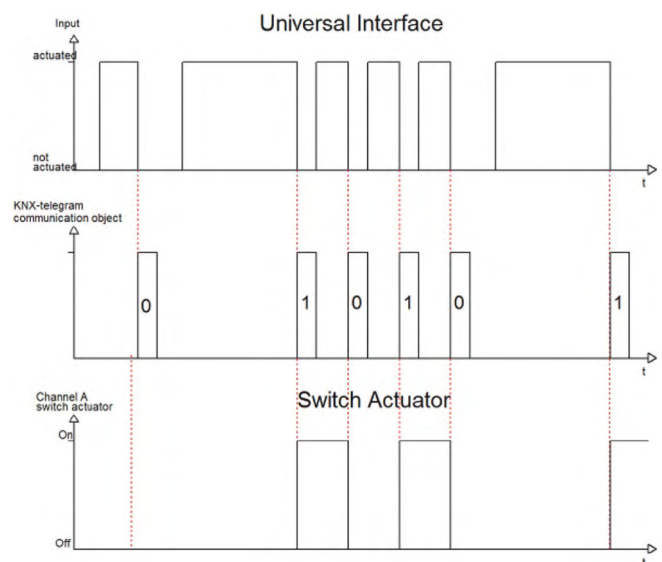

Figure 11: Drop delay flip

The table below for the corresponding communication object:

NO.	Name	Length	Purpose
0	Switch	1 bit	Pressing the key will send the corresponding signal, long/short press does not affect.
1	Value for toggle	1 bit	Connect status object, reflecting the current state of the target, for the rollover function.

Figure 13: Edge rollover object

The Value for toggle object is related to the normal implementation of the flip function. For this, it must be connected to the state object of the target channel or, if there is no target pair, to the Switch object of the local channel. It can also be configured to read and update the object value when the device is powered on, so that it is consistent with the target state.

2.5.1.3. SEND STATUS

When the channel is configured as a Switch and Send Status function, the channel can send the set value in an ascending or descending delay.

The following is the configuration diagram:



Function: Switch
 Subfunction: Send Status
 Value for push: On
 Value for release: Off
 Blocking Object: Inactive

Figure 12: Send status Value sub-function

Parameter description:

Parameter names	Range [Default value]	Remarks
Value for rising edge	On Off	Send a signal when pressed
Value for falling edge	On Off	Send a signal when released

Figure 14: Send status parameters

Description of objects:

NO.	Name	Length	Purpose
0	Switch	1 bit	Send switch value, no difference between long and short keys.

Diagram 15: the Send status object

The Send status function can be used to detect the closed state of the window. For example, if the window is open or closed, the Send Status function can be used to send the status of the window for monitoring. The current input status can also be sent periodically.

The following picture shows pressing send 0 signal and releasing send 1 signal:

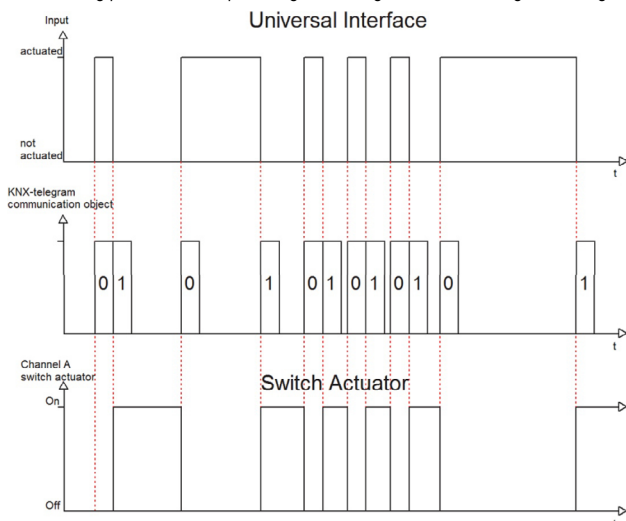

Figure 13: Send status value

2.5.1.4. EDGE DELAY SENDING VALUE (VALUE RISING/FALLING/SEND TO BOTH EDGES)

There are two values you can send, one 1 byte and one 2 bit, depending on your choice.

Parameter presentation:



Function: Switch
 Subfunction: Send value both edges (1Byte / 2Bit)
 Value (1Byte) / forced setting (2Bit): 1 Byte value
 Value for rising edge: 0
 Value for falling edge: 0
 Behaviour at Bus power up: send nothing
 Blocking Object: Inactive

Figure 14: Functional parameters

The following table shows the 1-byte value parameters:

Parameter names	Range [Default value]	Remarks
Value for rising/falling edge	0-255 [0]	Send on the set side extension (up extension, down extension). A 1 byte value.

Figure 16: One-byte value

For a 1-byte object, it can send any value in the range 0-255, depending on your Settings. The following is the object description:

NO.	Name	Length	Purpose
0	Send value	1 byte	Send set value

Figure 16: 1 byte object

The table below for the values of two parameters:

Parameter names	Range [Default value]	Remarks
Send forced setting at rising/falling	Forced setting not active Forced setting off Forced setting on	Send a 2-bit on the set side extension (rise extension, fall extension) Value.

Chart 17: One-byte values

This 2-bit object can be used for, for example, automated human sensing control. The parameters are described as follows: z Forced setting not active(control=0,value=0)

Human body sensor works properly.

▼ Forced setting off (control=1, value=0)

▼ Human sensors are forced to shut down and no longer sense the external environment

The body sensor is forced on.

2 bit value object:

NO.	Name	Length	Purpose
0	Send forced setting	2 bits	Send the set value.

Figure 18: 2-digit value object

2.5.1.5. SEND VALUE WITH ON/OFF DELAY

The following table describes the parameters of send delay:

Parameter names	Range [Default value]	Remarks
Delay time	0-60min [1s]	Send the value after the delay setting time

Figure 19: Delay sending parameters

To Send child function value with on/off delay, is Send on or off value, delay some time before we Send. If the channel returns to its previous state before the delay is complete, the delay ends early and no value is sent. For example, if the channel is pressed down, the On value is sent after a delay of 3 seconds, and the channel is released before the time interval is reached, the channel delay ends and the On value is not sent again.



The following is a demonstration of the operation:

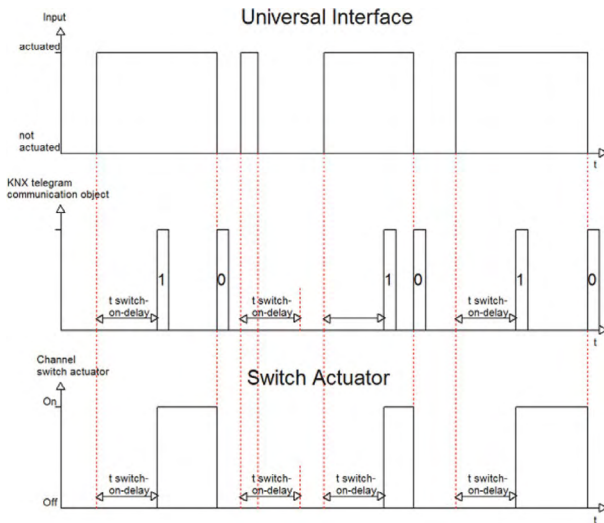

Figure 15: Delayed sending

Parameter graph:



Figure 16: Delay send parameter configuration

Object description:

NO.	Name	Length	Purpose
0	Switch	1 bit	Press the delay send On value to release the delay send Off value.

Figure 20: Delay send object

2.5.2. SCENARIOS (SCENE)

The scene function can be used to control multiple channels of one or more actuators to achieve a scene state. In addition, when the learning function is activated, learning commands can be sent through a long key.

The following figure shows the parameter configuration:

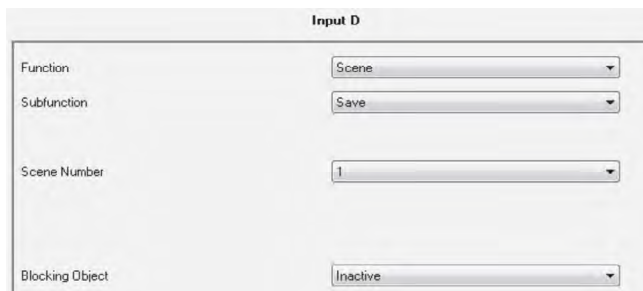

Figure 17: Scene parameters

The following table shows the parameters:

Parameter names	Range (Default value)	Remarks
Saving function	No save Save	When the save function is activated, the long key can learn and save the current channel value.
Scene number	1-64 [1]	Scene number, which must be configured to be the same as the actuator.
Blocking object	Inactive Active	Blocking object, disabled by default.

Figure 21: Scene parameters

Object description:

NO.	Name	Length	Purpose
2	Scene	1 byte	Send scene

Figure 22: Scene object

Short key is sent to set the scene, with the same group address actuators scene object will receive scene, and perform the corresponding action. When the learning function is activated, a learning command will be sent to the associated actuator through the long key, and the actuator will save the current channel state to the corresponding scene number.

The following table shows the corresponding values of scene sending and saving:

Scene	Send		Save	
	Hex.	Dez.	Hex.	Dez.
1	0x00	0	0x80	128
2	0x01	1	0x81	129
3	0x02	2	0x82	130
4	0x03	3	0x83	131
5	0x04	4	0x84	132
6	0x05	5	0x85	133
7	0x06	6	0x86	134
8	0x07	7	0x87	135
9	0x08	8	0x88	136
10	0x09	9	0x89	137
11	0x0A	10	0x8A	138
12	0x0B	11	0x8B	139
13	0x0C	12	0x8C	140
14	0x0D	13	0x8D	141
15	0x0E	14	0x8E	142
16	0x0F	15	0x8F	143
17	0x10	16	0x90	144
18	0x11	17	0x91	145
19	0x12	18	0x92	146
20	0x13	19	0x93	147
21	0x14	20	0x94	148
22	0x15	21	0x95	149
23	0x16	22	0x96	150
24	0x17	23	0x97	151
25	0x18	24	0x98	152
26	0x19	25	0x99	153
27	0x1A	26	0x9A	154
28	0x1B	27	0x9B	155
29	0x1C	28	0x9C	156
30	0x1D	29	0x9D	157
31	0x1E	30	0x9E	158
32	0x1F	31	0x9F	159

Figure 23: Scene Number vs. Save Value

2.5.3. AS LONG/SHORT PRESS THE SWITCH (THE SWITCH SHORT/LONG)

Long/long press can be independently assigned to on/off/flip/send value and other functions. The following image shows the parameter options:

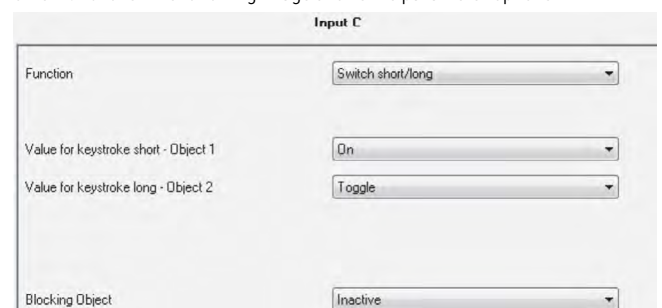

Figure 20: Long Press/short press parameters



The following table describes the parameters:

Parameter names	Range [Default value]	Remarks
Value for keystroke short object 1	On Off Toggle Send value Nothing	Value for
Value for keystroke long object 2	On Off Toggle Send value Nothing	on long
Blocking object	Inactive Active	

Figure 26: Long Press/Short press parameters

The table below for the object description:

NO.	Name	Length	Purpose
0	Push-button short	1 bit	Object, for short keystrokes
1	Value for toggle short	1 bit	Short key flip value
2	Push-button long	1 bit	Object, for long keystrokes
3	Value for toggle long	1 bit	Long key flip value

Chart 27: Long Press/Short press object

The single-key long/short key function can be used to control two channels, which saves one key. Or you can short press on, long press off, short press to flip, long press to flip, and so on. When configuring the flip function, the corresponding flip object must be connected to the status object of the controlled actuator channel to realize the correct flip.

The following figure shows the command description, long press/short press are set to flip function, long press to control actuator channel A, short press to control channel B:

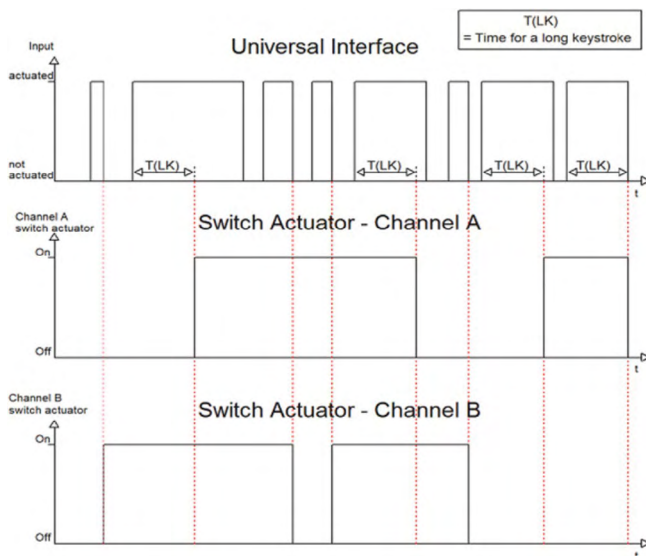

FIG. 21: The long/short press are independent

Below for short/long press press, long press to open, short press close:

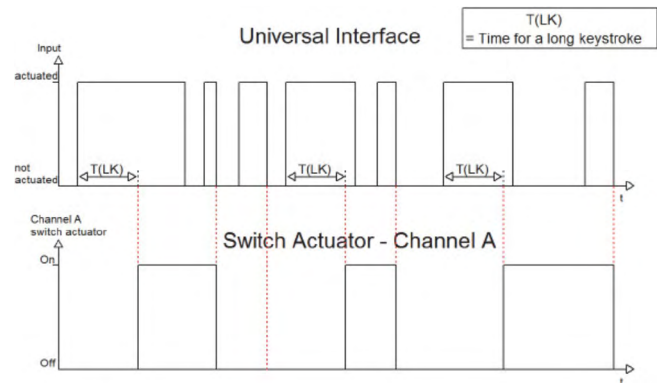

Figure 22: Long/short press together

The following table describes the parameters for the Send value of the selected function:

Parameter names	Range [Default value]	Remarks
Value for keystroke short/long	Send value	The subfunction is selected as the send value
Send value	1 Byte-Value [0... 255] Scene number	Choice of values: one is a 1-byte unsigned value, one is a scene value.
1 Byte-Value[0... 255]	0-255 [0]	One-byte unsigned value, ranging from 0 to 255. Can be used for control such as perfect dimming.
Scene number	1-64 [1]	One-byte scene values, ranging from 1 to 64. Can be used for scene control.

Figure 28: Send value parameters

2.5.4. A KEY MOVE LIGHT (ONE BUTTON DIMMING)

A single button can achieve dimming, on/off.

The following image shows the parameter options:

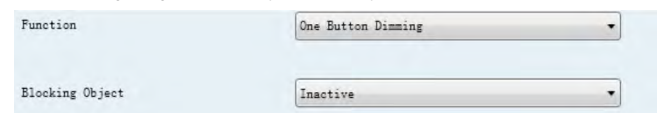

Figure 23: Single key dimming parameter

Parameter description:

Parameter names	Range [Default value]	Remarks
Blocking object	Inactive Active	Blocking function

Figure 29: Single key dimming parameters

Description of objects:

NO.	Name	Length	Remarks
0	Dimming on/off	1 bit	Same switch function, short key effective, every flip.
1	Dimming	4-bit	Relative dimming, long keys work.
2	Value for toggle	1 bit	Receive channel status value.

Chart 30: Single key dimming object

Single key dimming enables on/off, dimming functions. Short keys function the same as switches, flipping each key. The long key achieves relative dimming, the brightness no longer changes when the maximum/minimum value is reached, and the release key stops dimming. Because it is single key dimming, the direction changes each time the long key dimming is done. Assuming the current dimming direction is up, the next dimming direction is down. The dimming step should be 100% each time.



Below for dimming:

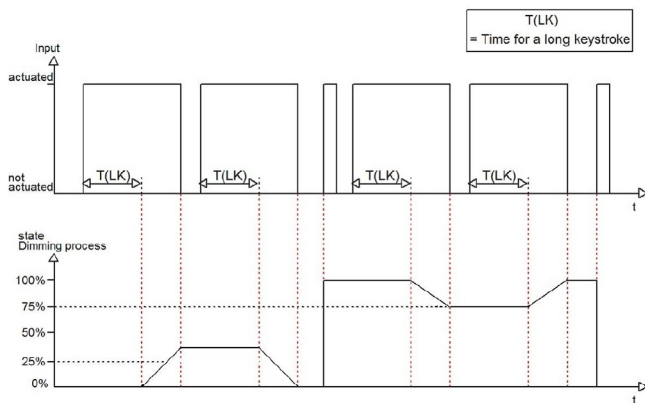

Figure 24: Single key dimming

2.5.5. SINGLE BOND CURTAIN CONTROL (ONE BUTTON SHUTTER)

Single button curtain control.
Here are the parameters:



Figure 25: Curtain control

Parameter description:

Parameter names	Range [Default value]	Remarks
Blocking object	Inactive Active	Blocking function

Figure 31: Curtain parameters

Description of objects:

NO.	Name	Length	Remarks
0	Shutter	1 bit	Curtains move, long keys work.
1	Blinds/Stop	1 bit	Curtain stop, short key effective.
2	Value for change of direction	1 bit	Indicates the current direction.

Figure 32: Curtain object

The long key controls the curtain movement, changing direction each time it moves and, assuming it is currently moving up, moving down the next time. Send a Stop command through the object Blinds/Stop when pressing a short key.

2.6. LOGIC (LOGIC)

The device contains four logic control blocks. Each logic block can be configured with two external logic objects and a device key as input, off performs logic and/or operations, and then, outputs a switch quantity signal, byte value, or scene value.

Logical operations can be used in situations where there is a conditional choice of requirements. For example, a lamp can be turned on only when both external signals are 1. Then, the control signal can be output after the two signals are logical and operated. Then, only when both external signals are 1, the lamp will be on.

Parameter diagram:

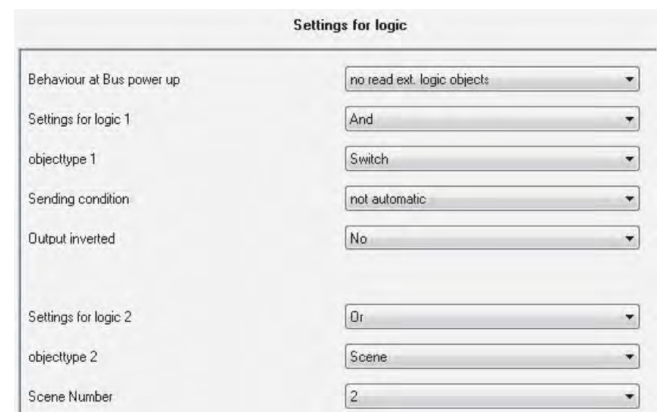

Figure 27: Logical block function configuration

Parameter description:

Parameter name	Range [Default value]	Remarks
Behavior at bus power up	No read ext.logic objects Read ext.logic objects	Specify whether to read logical object values when the device is powered on. When configured to power read, the device reads and updates the outer. Part of the value of the logical object, otherwise the default value is 0.

Figure 35: Logical block power-on configuration

The following table shows the feature selection:

Setting per logic [default value]	Dynamic range [Default value]	Notes
Disabled And	Switch Scene	Logical objects can be configured for And/Or operations, and optional features are switch/scene/1 byte value three.
Or	1 byte value	

Figure 36: Feature selection

Object description:

NO.	Name	Length	Purpose
40	Logic input 1A	1 bit	External logic input object, valid when activated.
41	Logic input 1B	1 bit	External logic input object, valid when activated.
42	Logic output 1	1 bit	Logical output object, valid when activating the switch function.
42	Logic output 1 Scene	1 byte	Logical output object, valid when scene or 1 byte value is activated.

Figure 37: Logical object

There are four groups of logical objects in total, and the remaining three groups of objects are numbered from 43 to 51 and function as above.

When a logical block is activated, a new parameter configuration box will appear. More parameters to choose from. Two external logical objects can be selected to activate or not, after activating the corresponding object can be configured with the group address. In addition, all channels of the device can choose whether to join the logical operation.



The following figure shows the input options, including two external logical objects with 8 channels:



Figure 28: Input Configuration

2.6.1. SWITCH FUNCTION (LOGIC OBJECT TYPE SWITCH)

The following table describes the parameters:

Parameter names	Range [Default value]	Remarks
Send condition	Not automatic Change of input Change of output	Set the output criteria.
Send value	1 Byte-Value [0... 255] Scene number	Choice of values: one is a 1-byte unsigned value, one is a scene value.

Figure 38: Switch function

For send condition change of input, output state when any active input state changes. For a change of output of a send condition, the state is only output if all input signals have performed the set logical operation and the resulting state is not the same as before.

As for the reverse output function, it means that when the result of the logical operation is 0, the output is 1, and when it is 1, the output is 0.

Below for signal shows that the logical function is configured to Switch, And operation, activate channels A/B, And an external logic object, output the reverse:

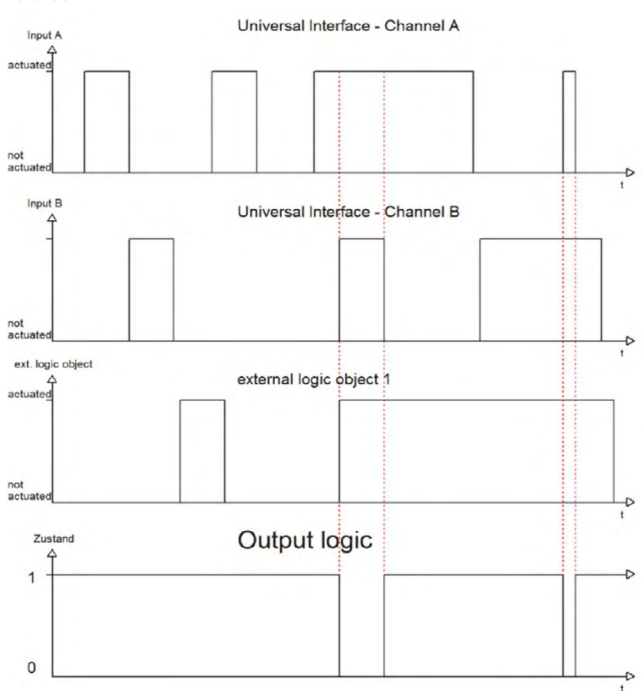

Figure 29: Logic output

The result of the And operation is 1 only if all three inputs are 1, the output is 0 after the reverse, And the output is 1 at other times.

2.6.2. SCENE FUNCTION (LOGIC OBJECT TYPE SCENE)

After the logical block is configured as the scene function, the set scene value will be output when the logical operation result is 1, and the scene value will be output once only when the logical operation result changes from 0 to 1 each time.

The following table describes the parameters:

Parameter names	Range [Default value]	Remarks
Scene number	1-64. [2]	Scene number set.

Figure 39: Logical scenario

2.6.3. LOGIC OBJECT TYPE BYTE VALUE (LOGIC OBJECT TYPE BYTE VALUE)

The following table shows the byte value parameters:

Parameter names	Range [Default value]	Remarks
Byte value[0... 255]	0-255. [0]	Byte value to send.

Chart 40: Byte values

As with the scene function, as long as the logical operation results in 1, the byte value set once is output.

